

KR XMatch Software

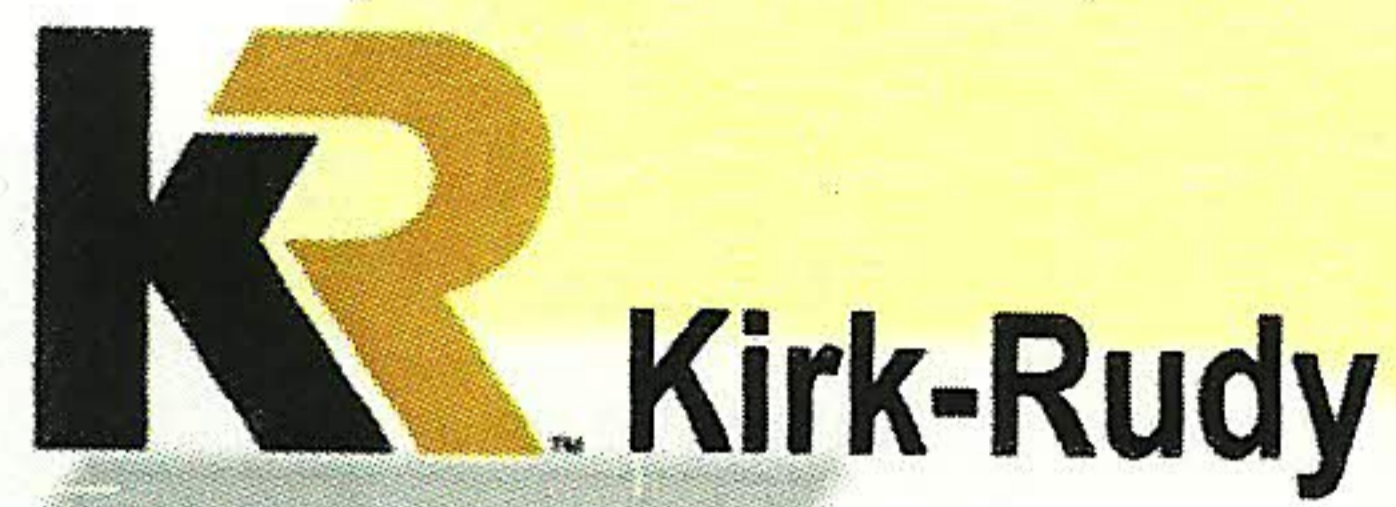

XMatch Software



Read and Print

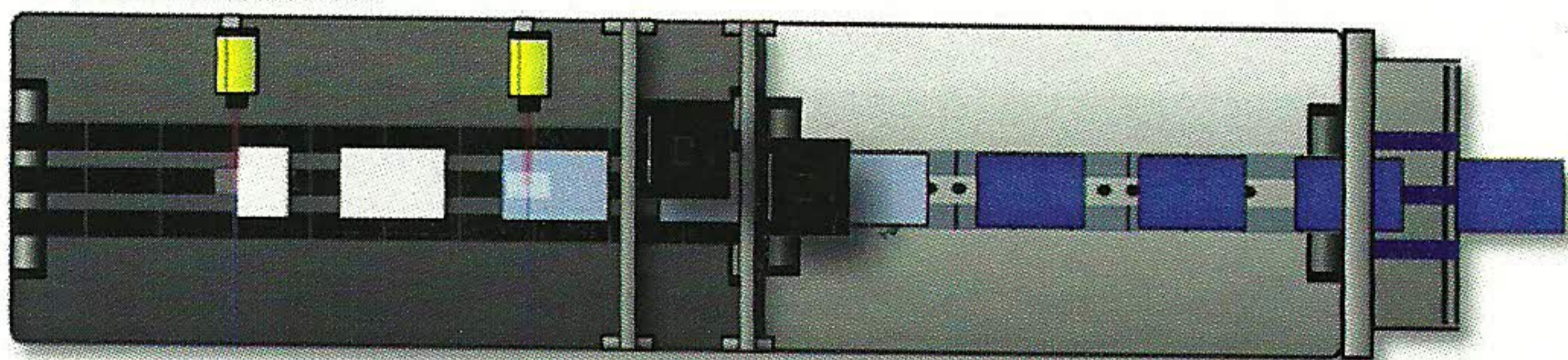

Print & Verify

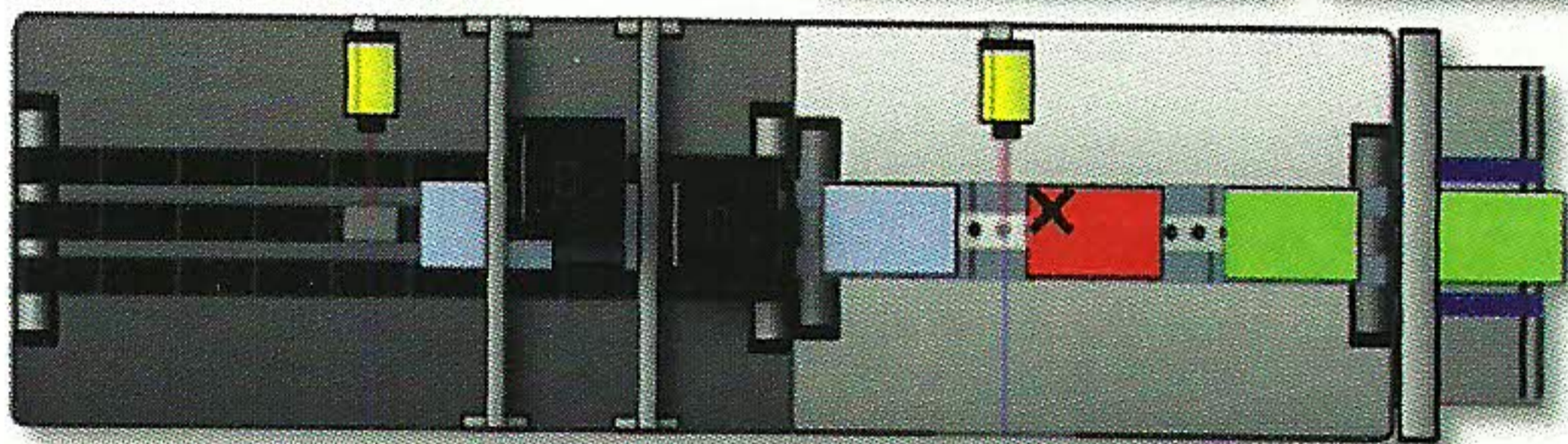

Duplex

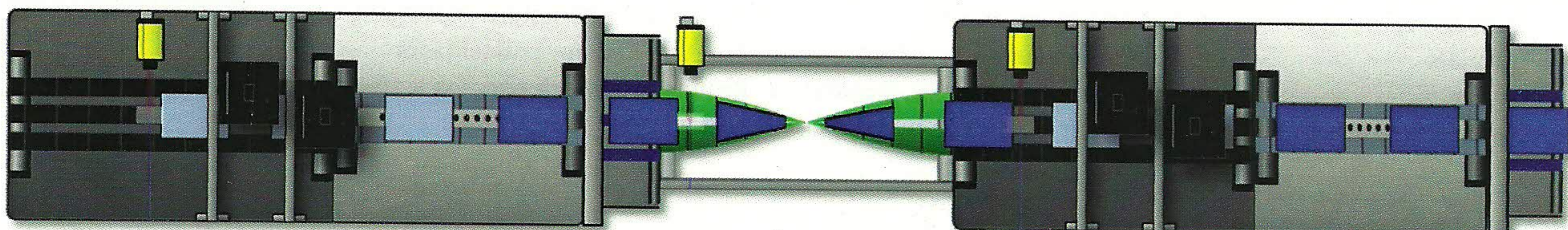

Features

- Drag n Drop Configuration

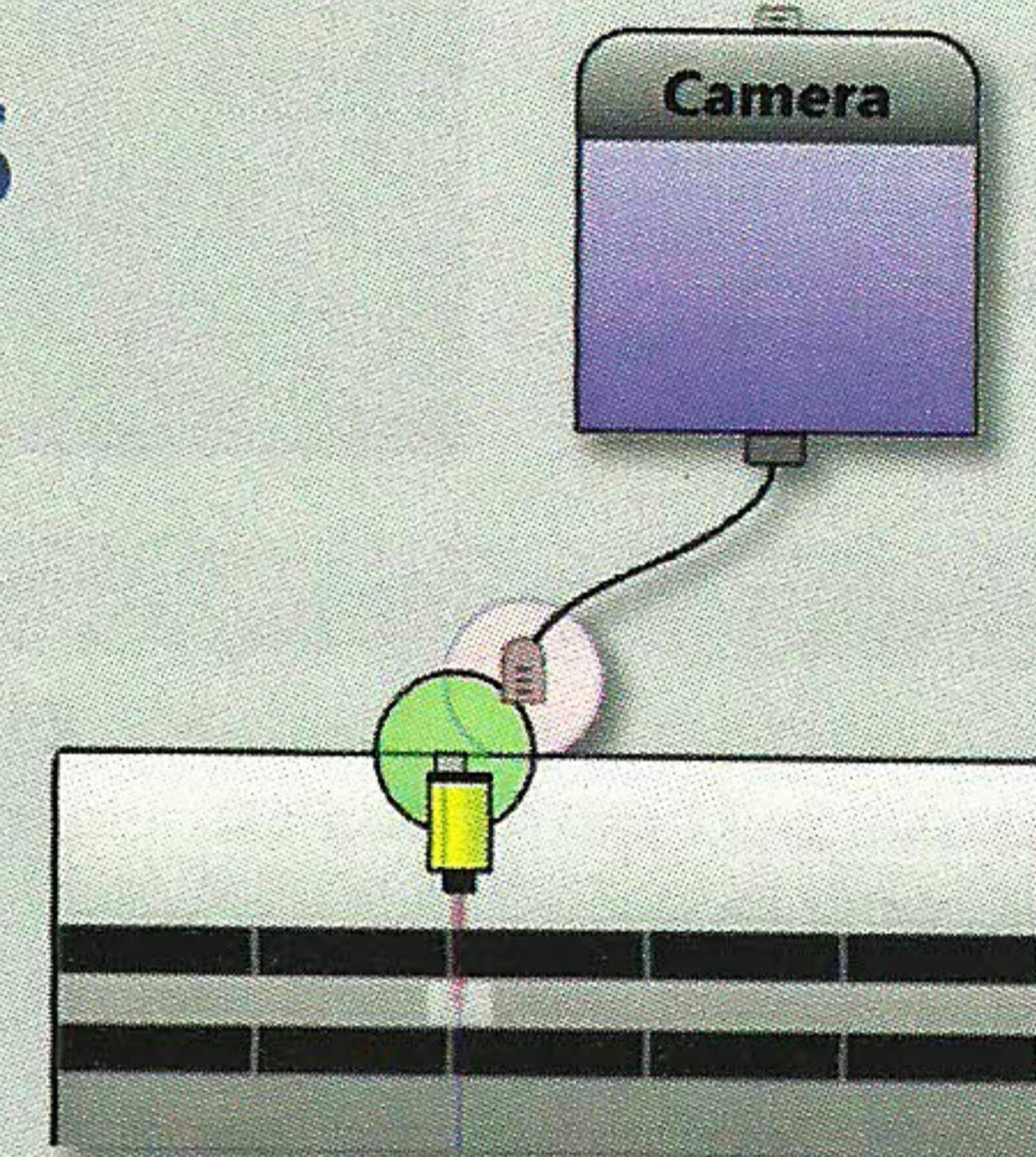

- Configuration Wizard – Easy system setup
- Integrated Vision – Directly configure cameras and OCR or Barcode regions
- Reports – View or export to file
- Job Progress – Color coded view of entire database
- Integrated Help and *Videos!* Videos allow new operators to learn and use the system with minimal training

KR XMatch Software

** General Specifications

Configuration Simplicity

Drag-n-Drop
Connect devices and define IO by dragging and snapping wires

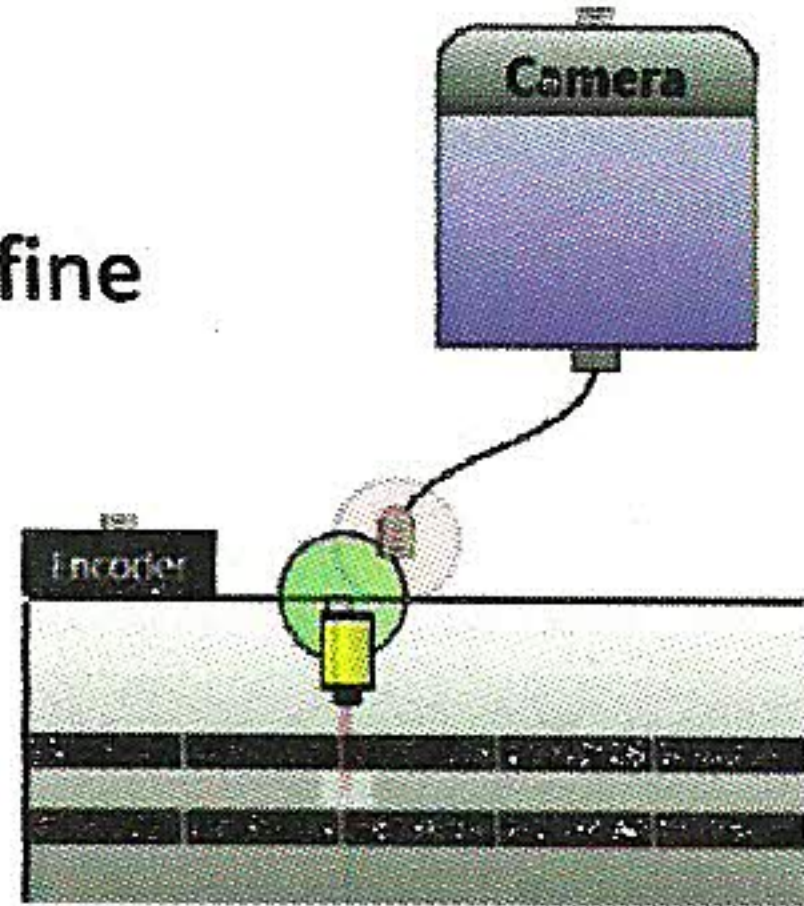

Visual Browser - Easily search and view configs before opening

Builder Wizard - Detects system config step by step

Distance Indicators

Drag sensors into position

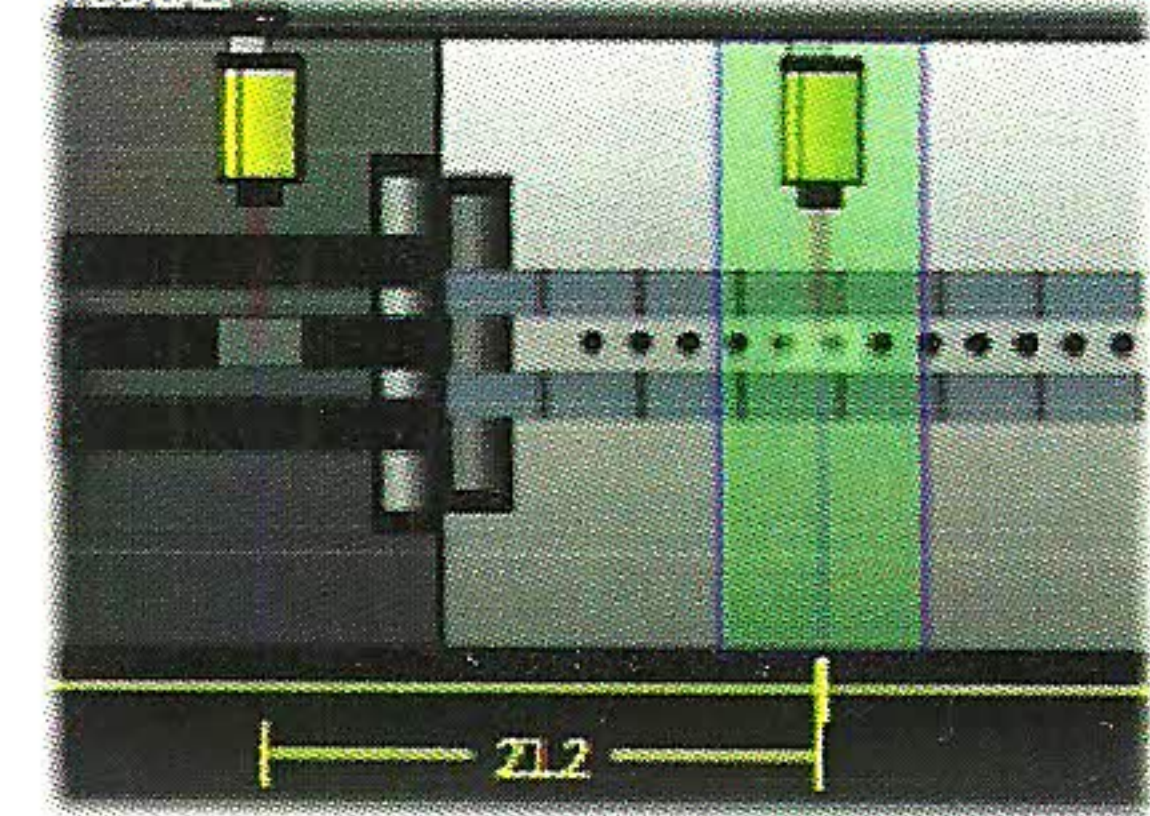

Integrated Vision

Connect and configure Camera and regions

Barcode Region
All major 1D and 2D types

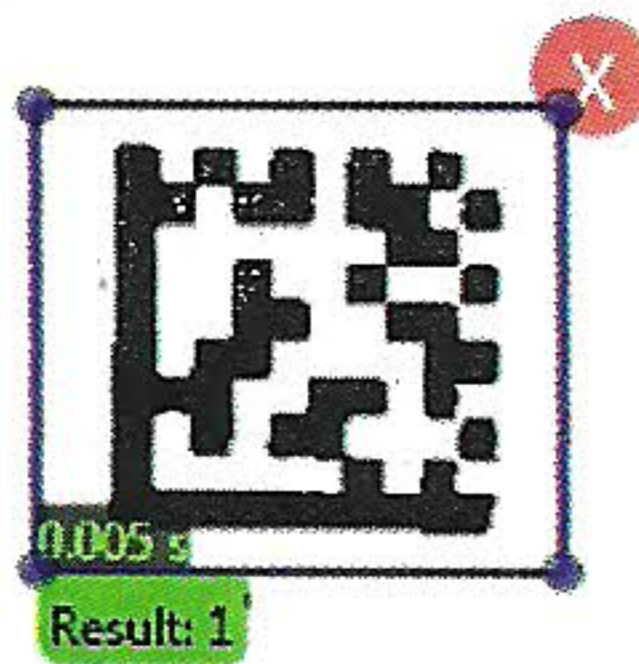

Simple OCR

- "Type what you see"
- Multipass decoding
- Image Filters

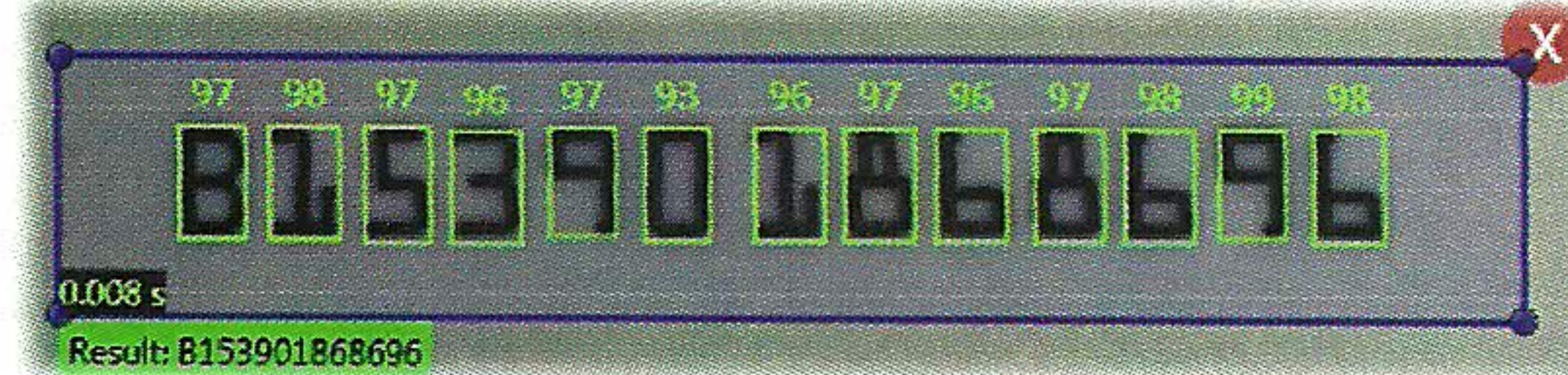
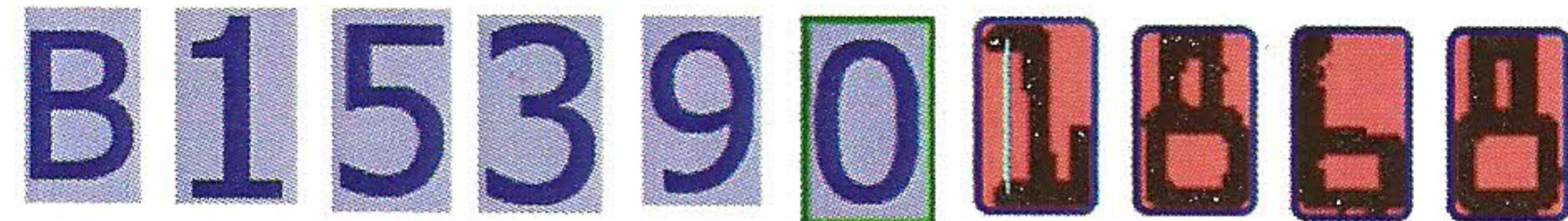

Reports and Printing

Record History

- All records tracked
- Reprint prevention
- Visual History

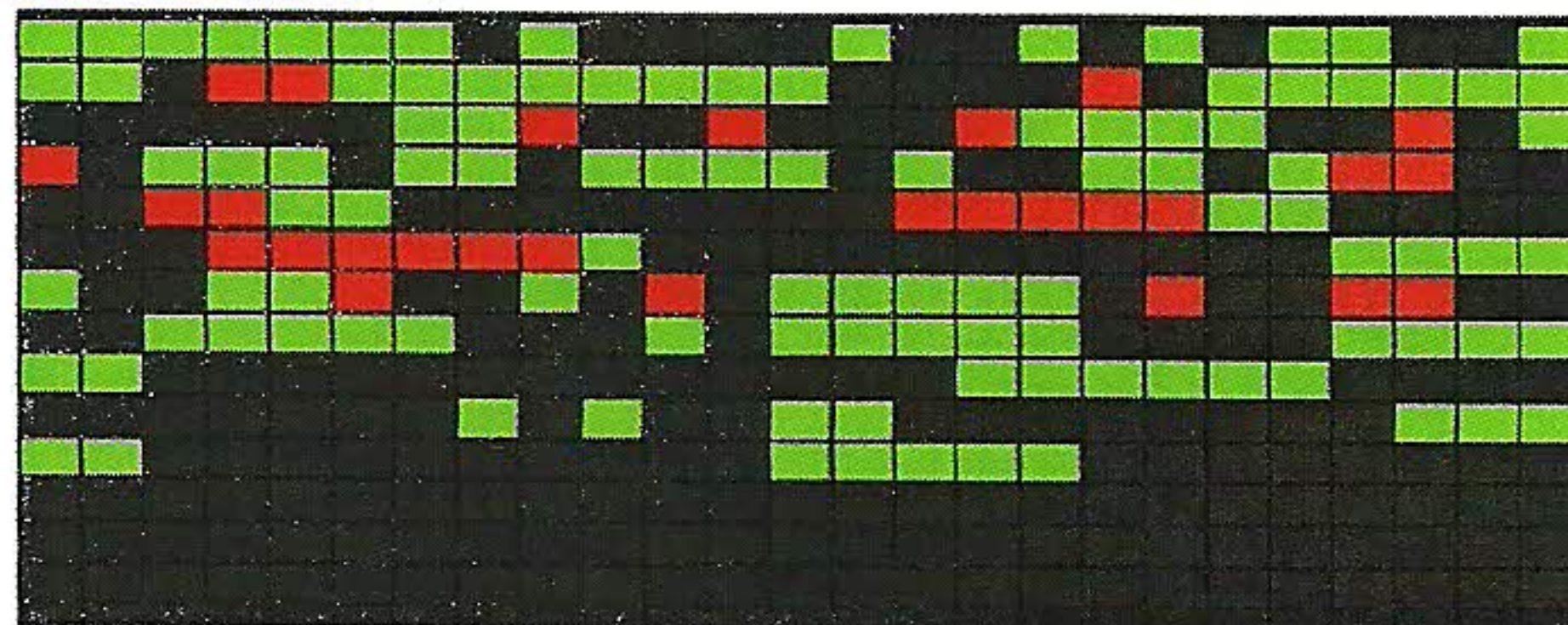

Report Exporting

- Export to CSV
- Every product
- Date, Record, Printed, Result, Diverted, Camera Data

Date	Time	Record	Printed	Name
8/16/2011	4:44:12 AM	10888	True	Printed
8/16/2011	4:44:14 AM	10889	True	Printed
8/16/2011	4:44:25 AM	10890	True	Printed
8/16/2011	4:44:30 AM	12794	True	Printed
8/16/2011	4:44:45 AM	12795	True	Printed
8/16/2011	4:44:47 AM	12796	True	Printed
8/16/2011	4:44:48 AM	12797	True	Printed
8/16/2011	4:44:48 AM	12798	True	Printed
8/16/2011	4:44:48 AM	12799	True	Printed
8/16/2011	4:44:48 AM	12800	True	Printed
8/16/2011	4:44:48 AM	12801	True	Printed
8/16/2011	4:44:48 AM	12802	True	Printed
8/16/2011	4:44:48 AM	12803	True	Printed
8/16/2011	4:44:48 AM	12804	True	Printed
8/16/2011	4:44:48 AM	12805	True	Printed
8/16/2011	4:44:48 AM	12806	True	Printed
8/16/2011	4:44:48 AM	12807	True	Printed
8/16/2011	4:44:48 AM	12808	True	Printed

Productivity Monitoring

- Monitor shift performance
- Daily PPH chart
- Daily Total/Pass/Fail

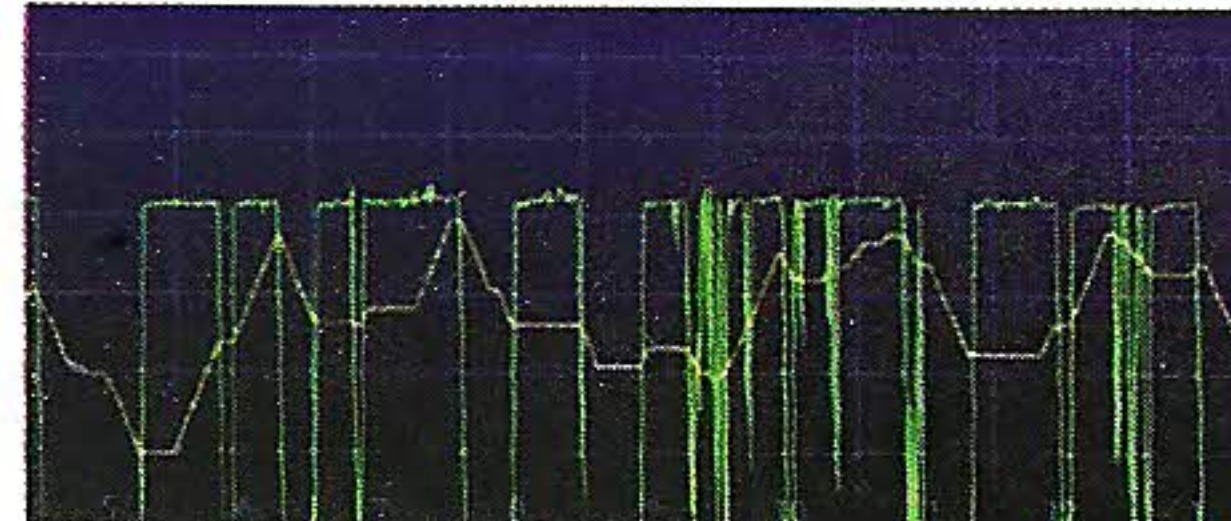

Date	Total	Passed	Failed	Duplicate
8/16/2011	132304	131236	1068	0
8/15/2011	320560	316019	4541	0
8/14/2011	278035	274392	3643	0
8/13/2011	321038	318022	3016	0

Reliability

Hybrid hardware/software tracking

- Eliminates timing errors
- Sub-millimeter tracking accuracy
- Double feed detection
- Product slippage detection

Performance Monitoring

- Image loads
- Barcode & OCR decoding
- Memory usage
- Data lookup durations

One Click Log Zipping

- .zip format
- XDR
- Reports
- Camera Images

Automatic Backups

- Every configuration
- Saved when config changes
- View changes between versions
- View # printed for each version

XMatch Data Recorder (XDR)

- Entire job's run is recorded to file
- File is size of an MP3
- Always running in the background
- 1 year history
- Stores every job and config setting

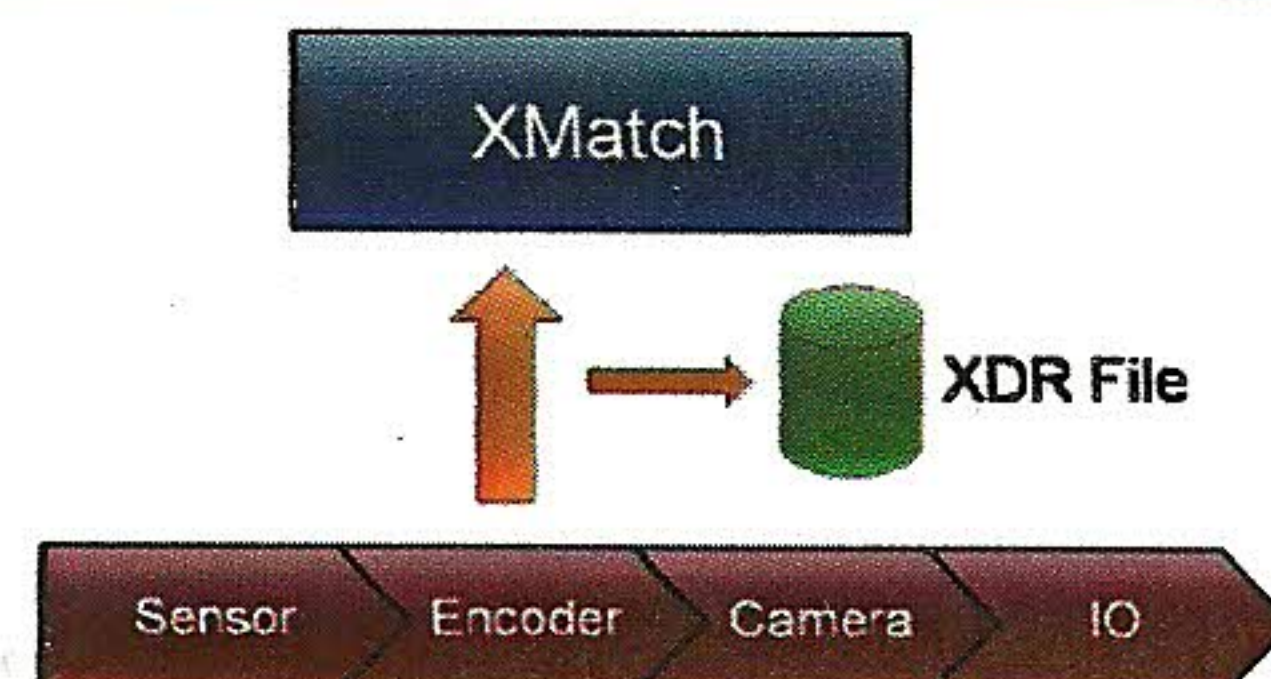

XDR Player

- Playback XDR files without XMatch
- Watch job run exactly as it did on the system
- Scan and fast forward directly to errors
- Pause, slow motion, fast forward, skip

Other Features

Integrated Help and Videos

- Quickstarts
- Tutorials
- Videos
- Detailed Reference

Emulator

- Full testing of XMatch
- Built in emulators provided
- (Read and Print, Verify, Duplex)
- Build your own (drag-n-drop)

Graphics Hardware Acceleration

- UI uses GPU (Graphics Processing Unit)
- Frees up CPU for critical tasks
- Results in XMatch needing < 1% CPU for tracking

